

LEGO

6096

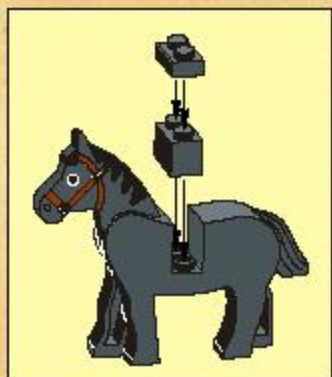

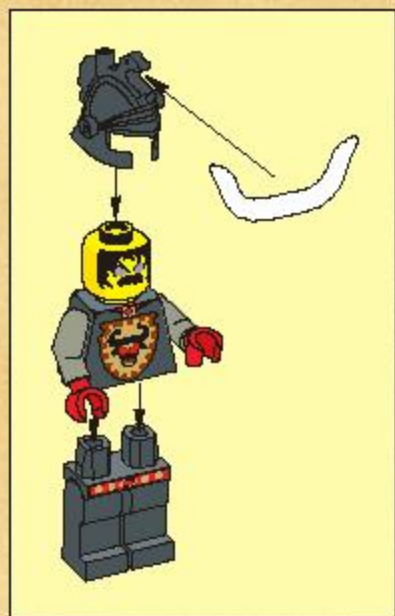

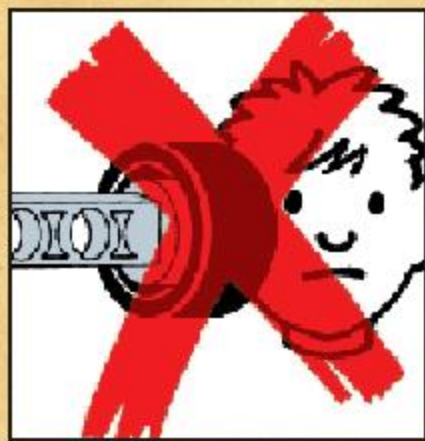
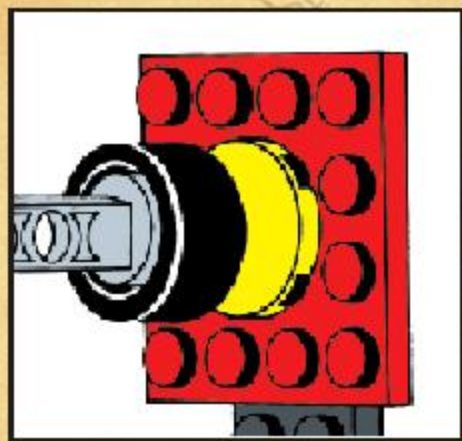

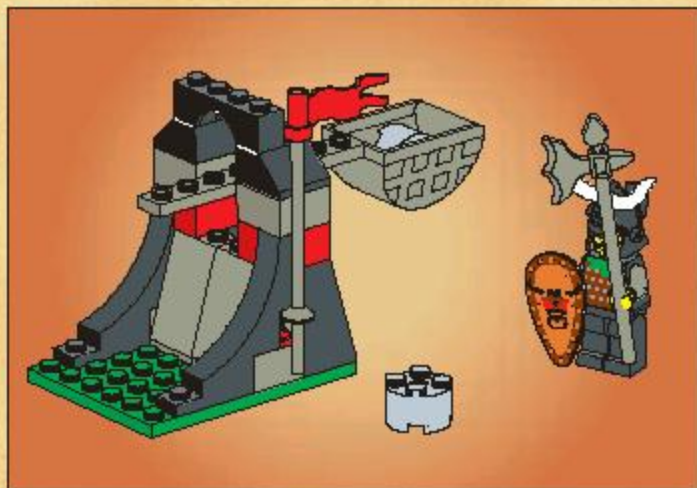

4

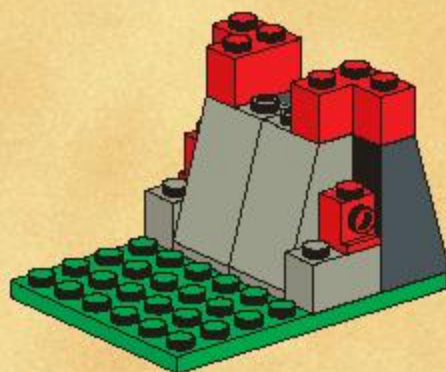

1

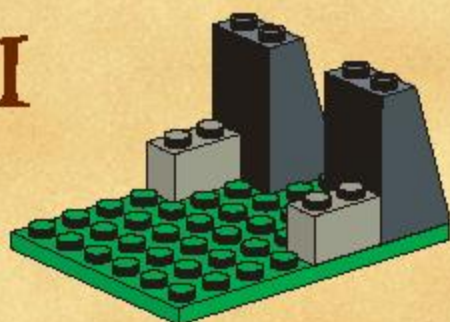

5

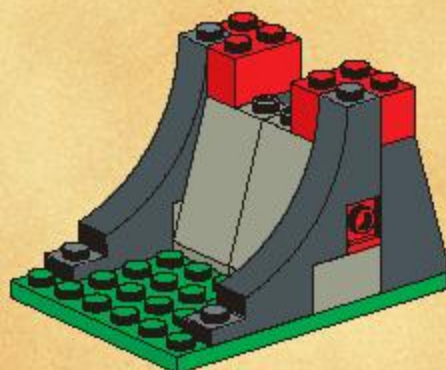

2

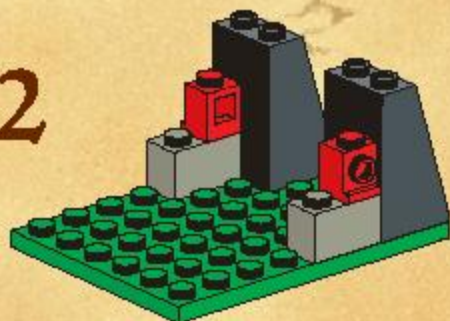

6

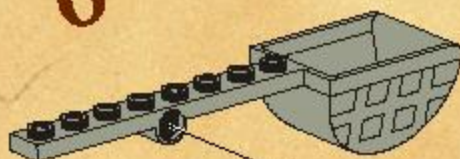

3

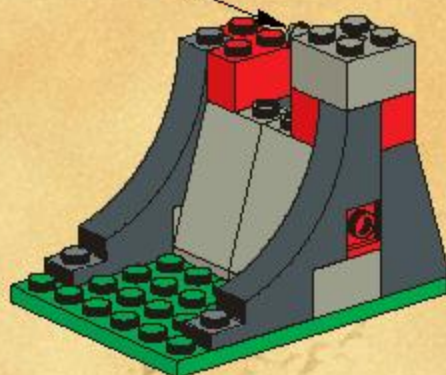
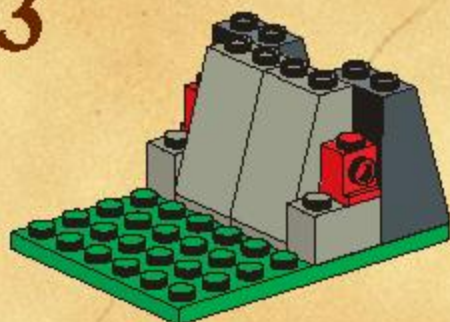

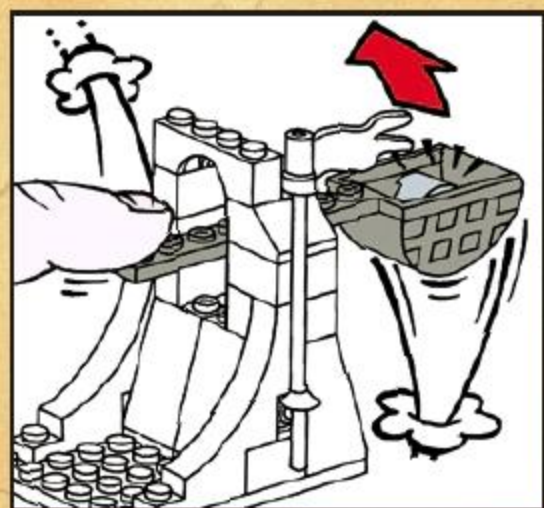
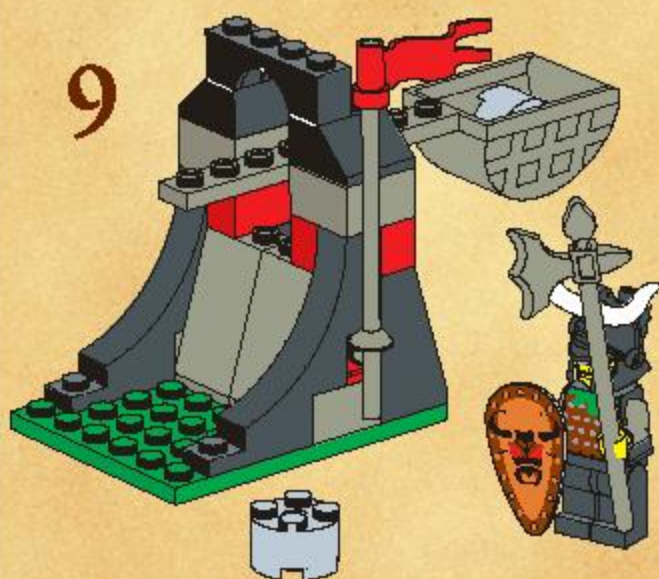
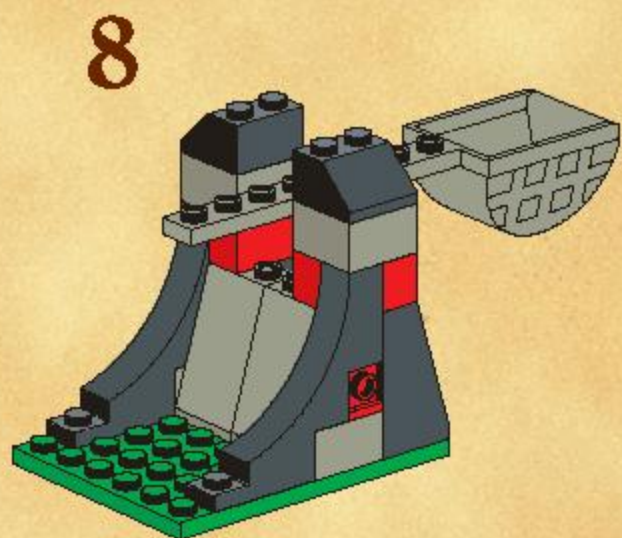
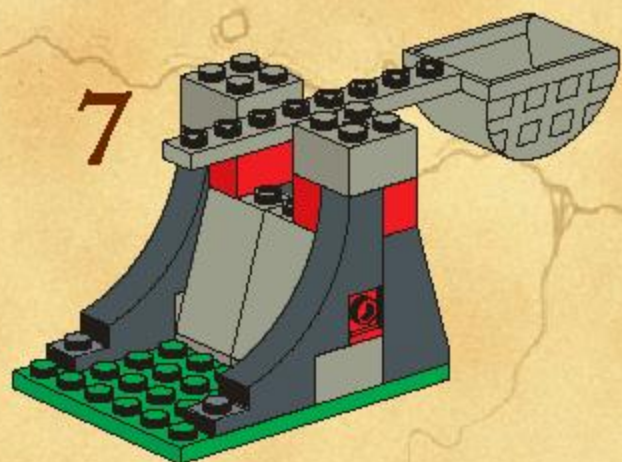

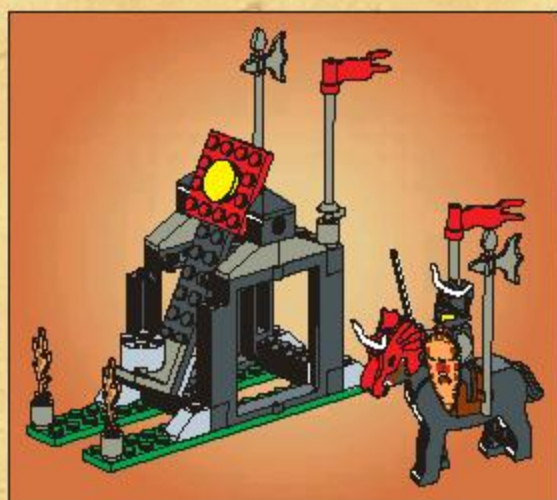

1

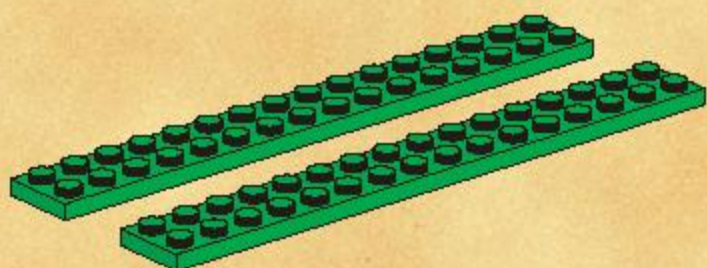

2

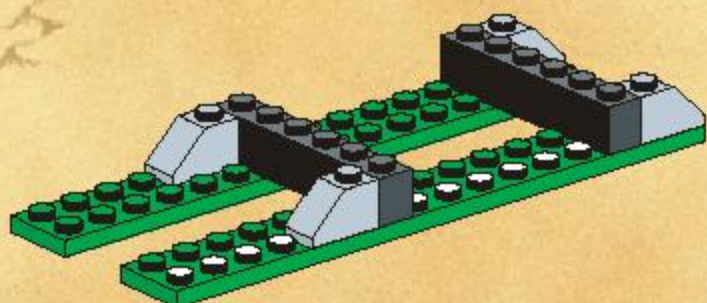

3

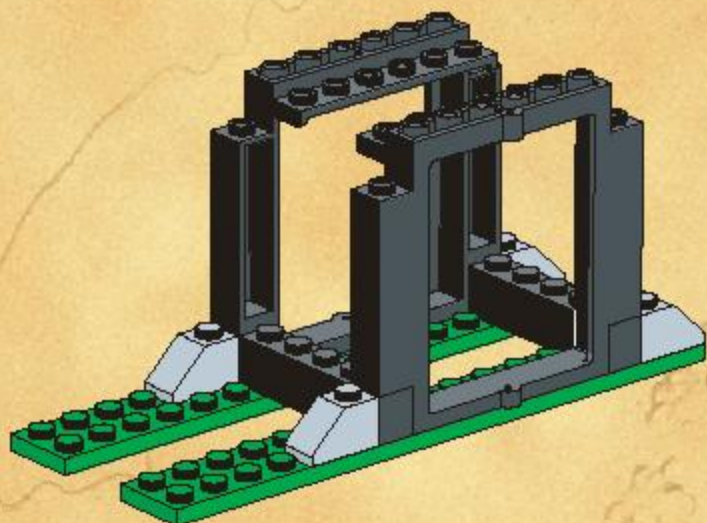

4

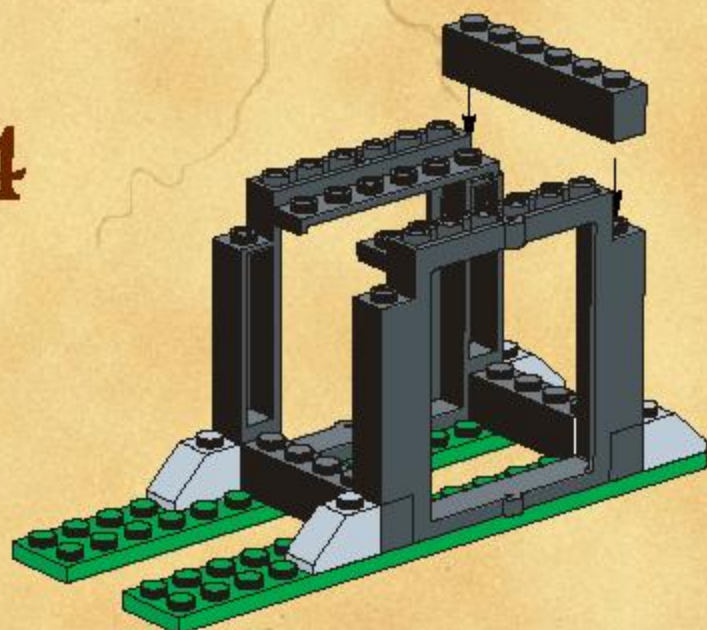

5

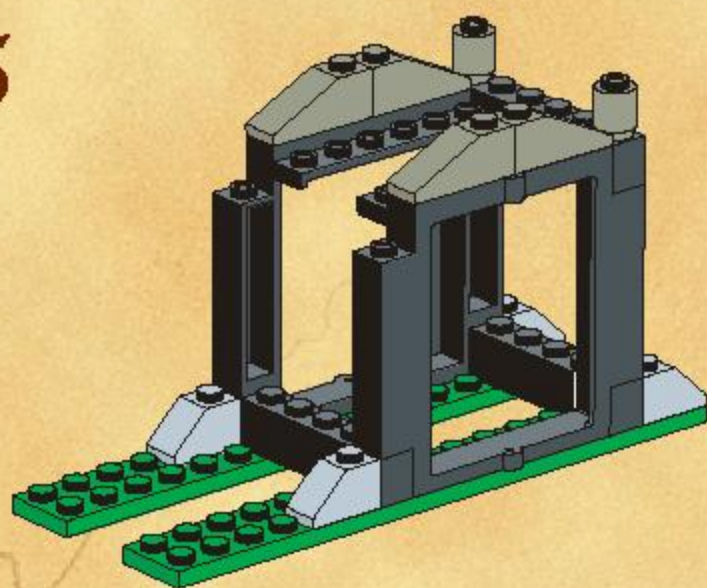

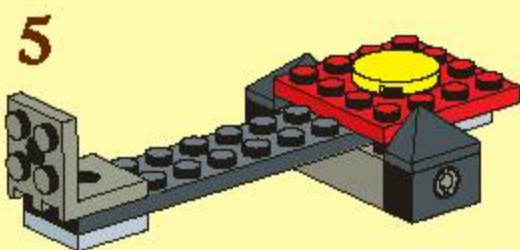
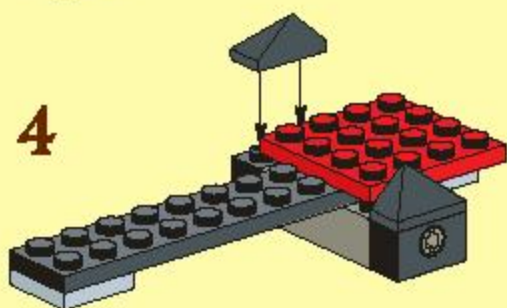
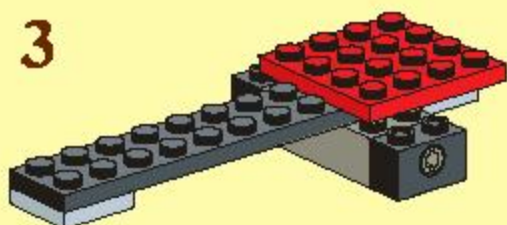
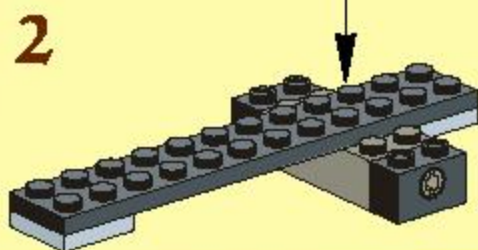
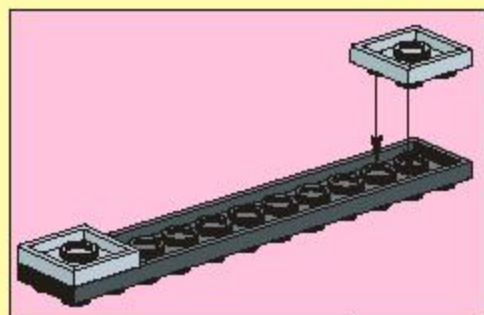
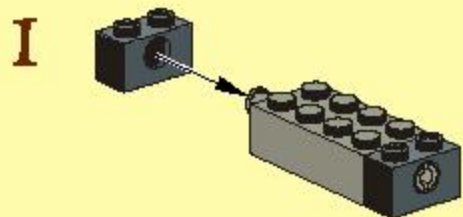

6

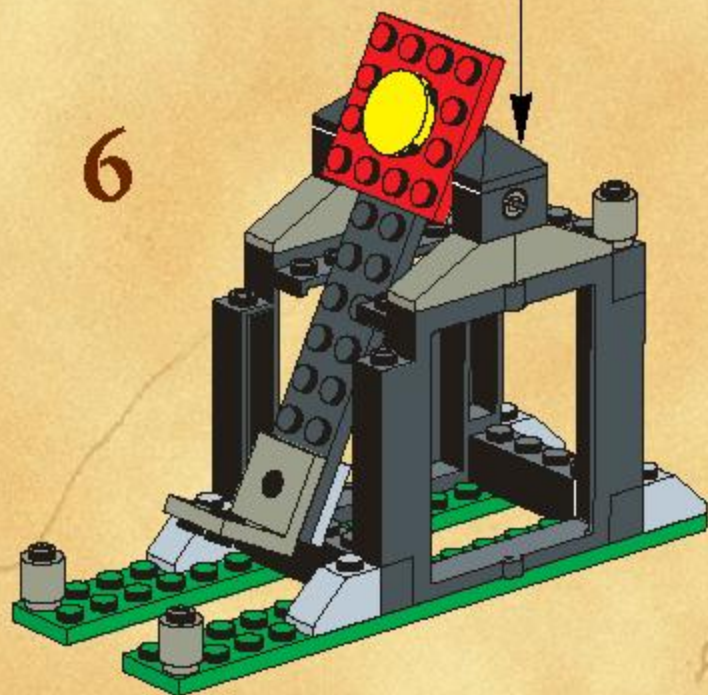

7

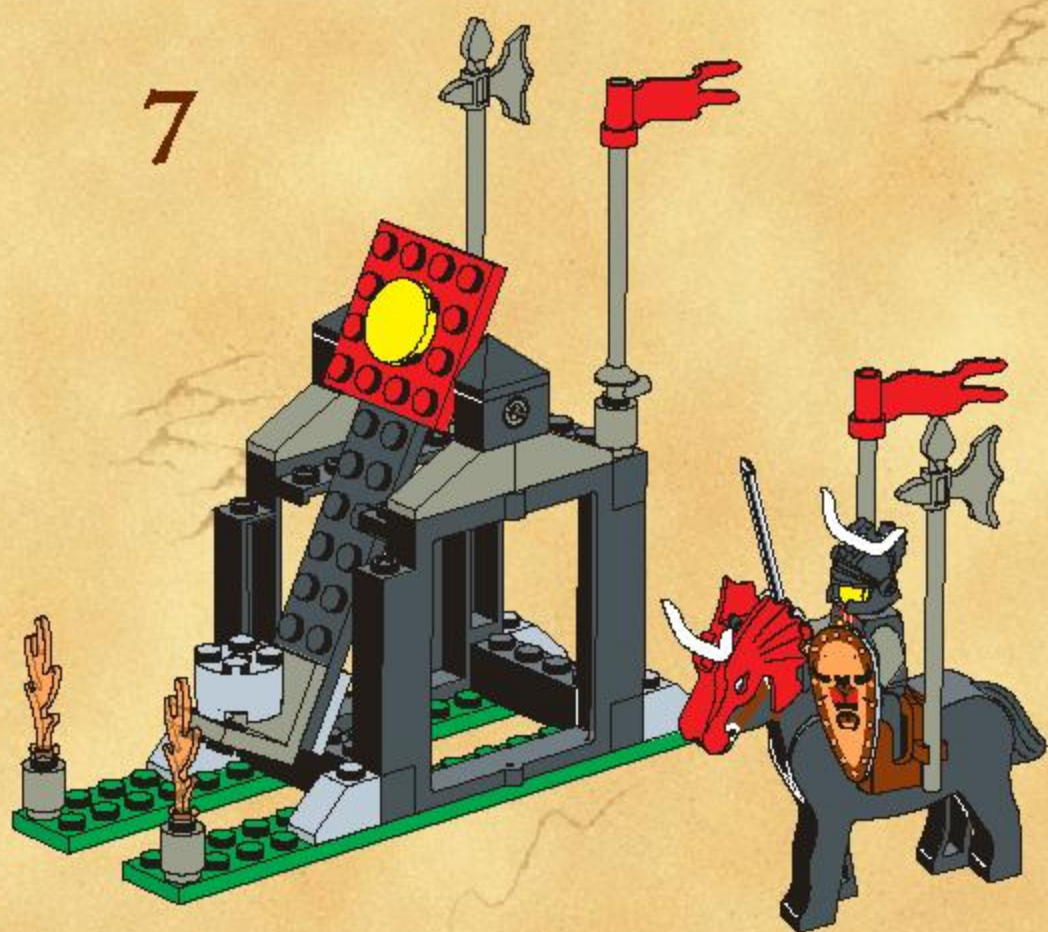



1

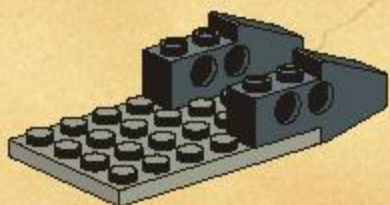

2

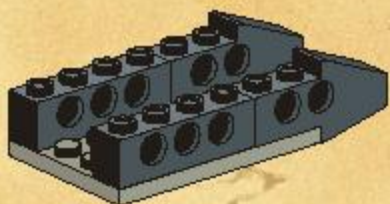

3

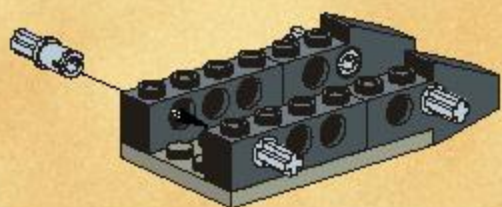

4

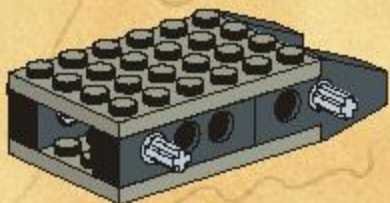

5



6

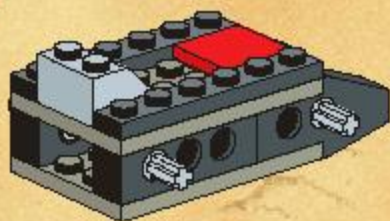

7

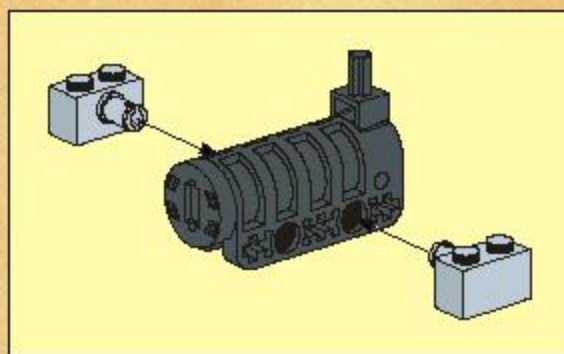
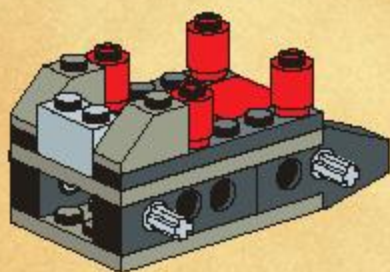

8

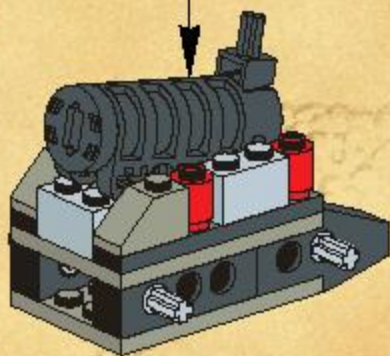

9

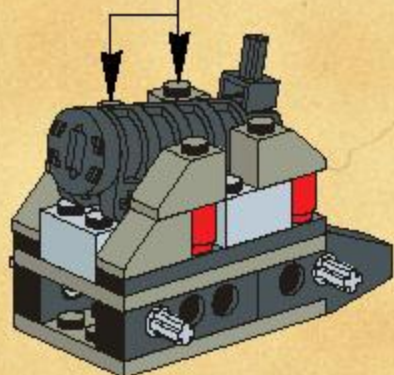

12

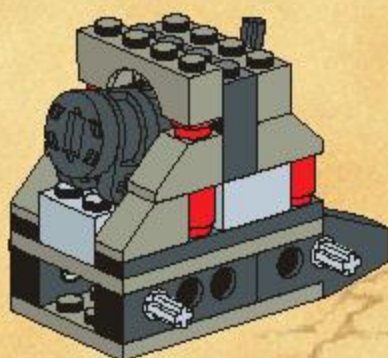

10

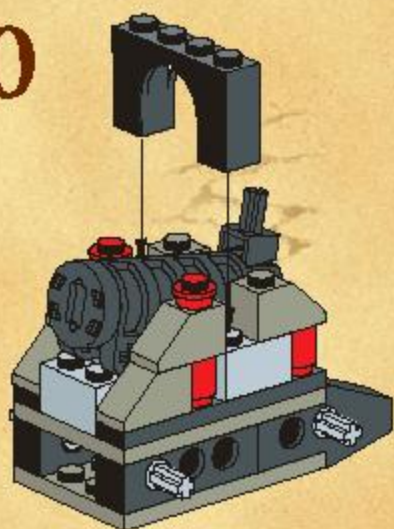

13

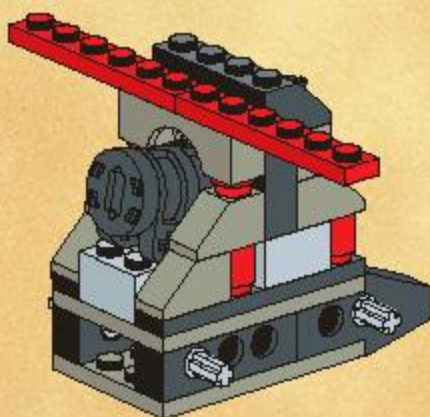

11

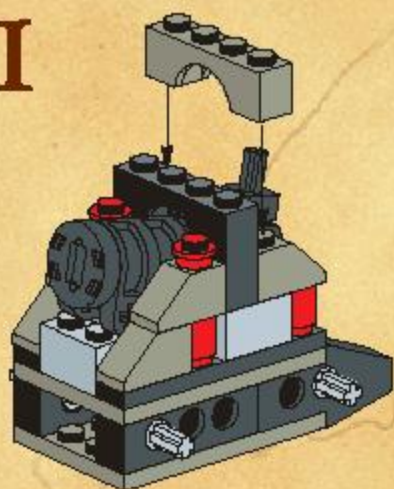

14

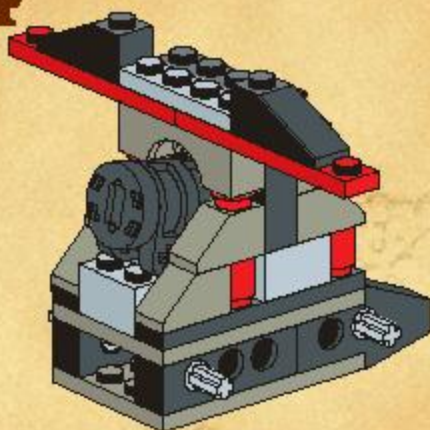

15

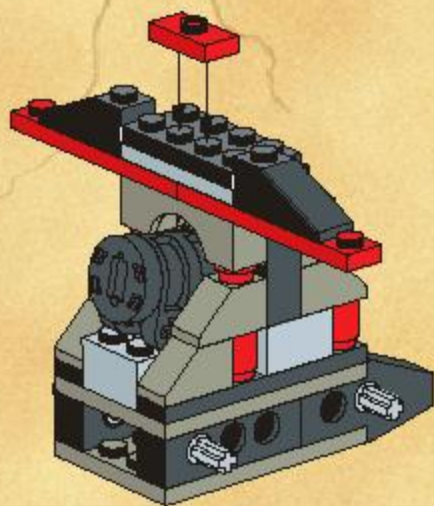

16

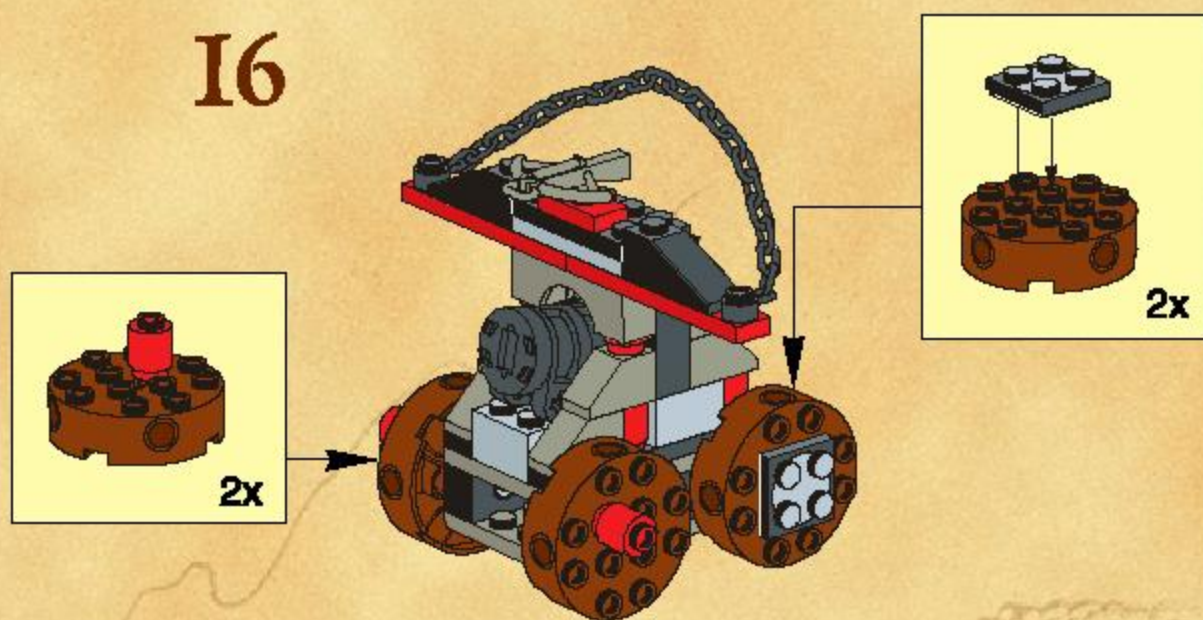

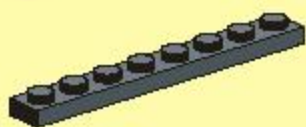
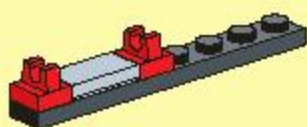
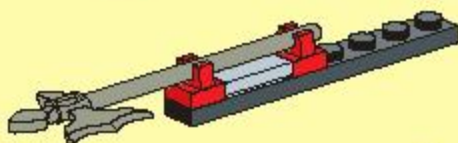
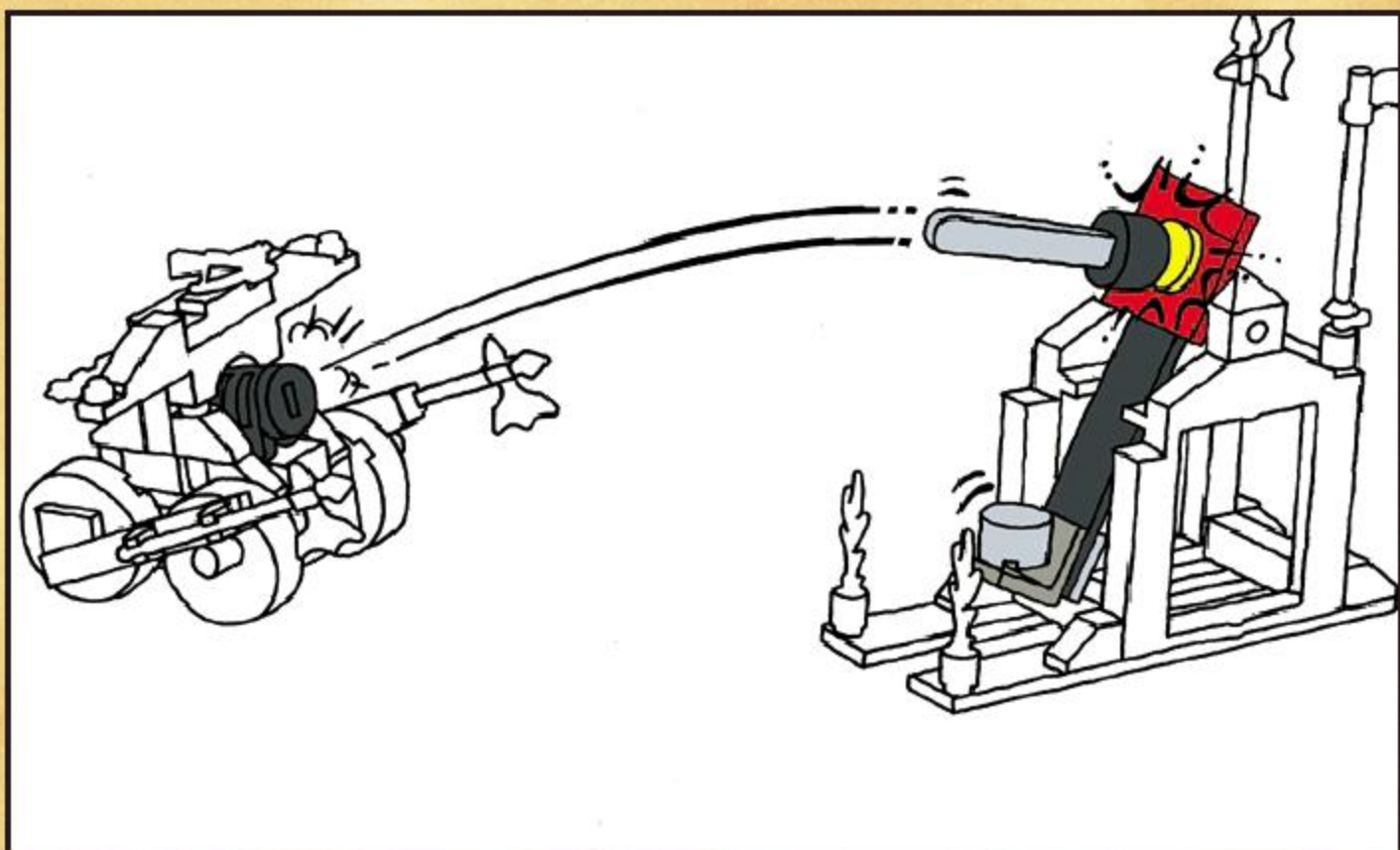
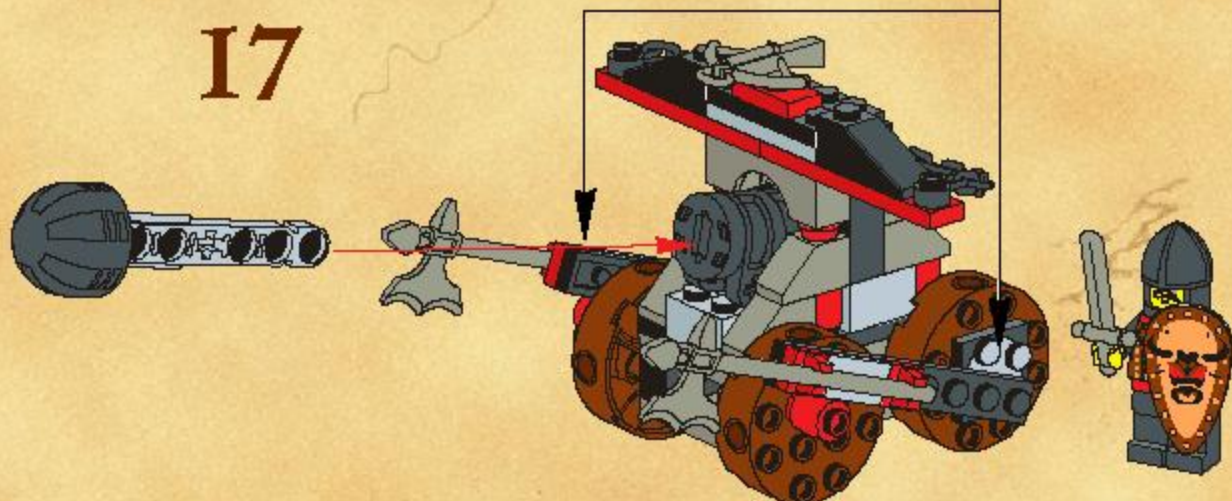
I**2****3****2x****17**



1

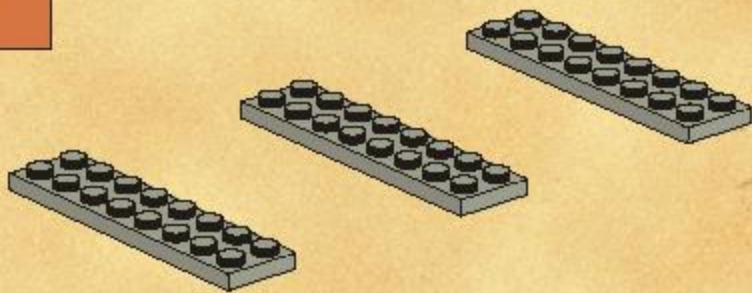

2

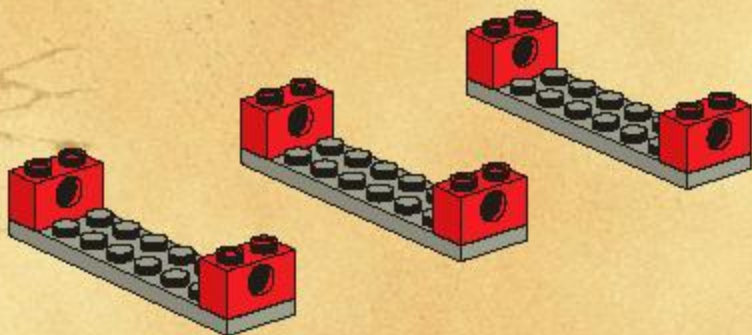

3

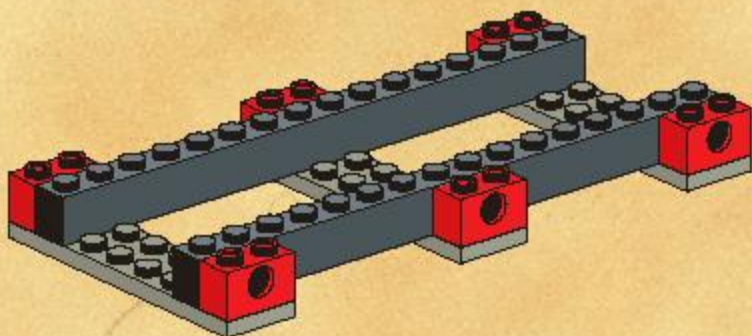

4

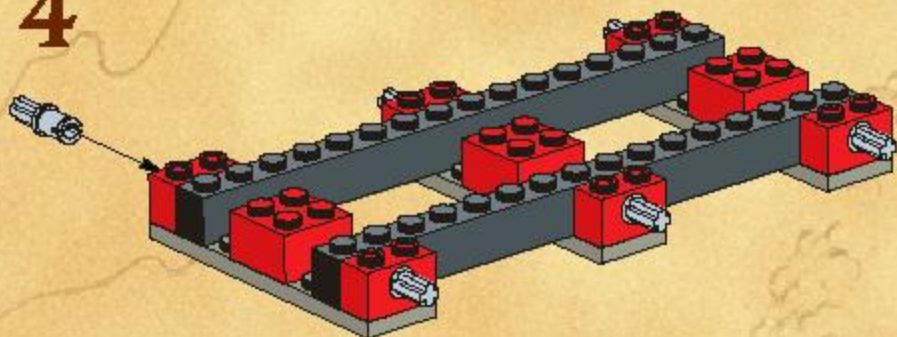

5

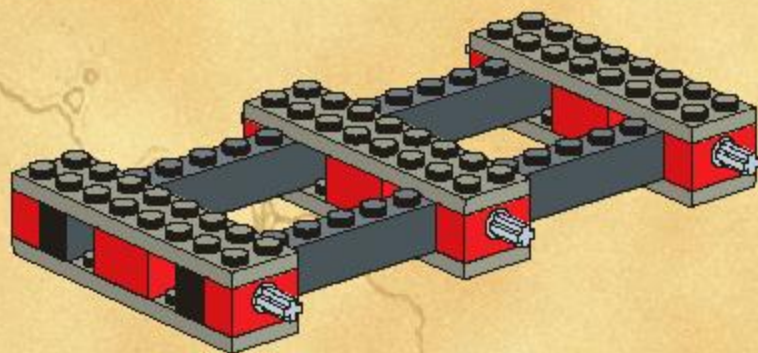

6

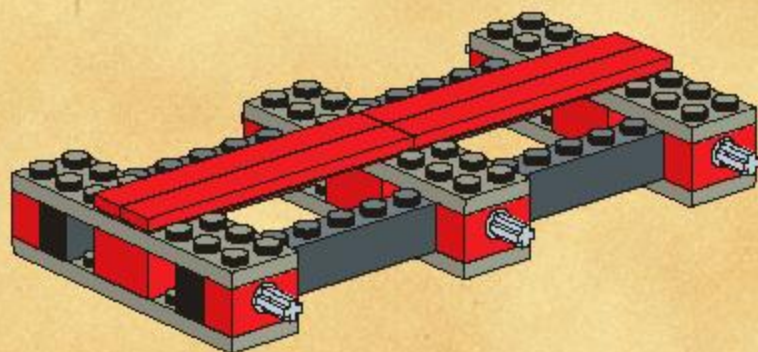

7

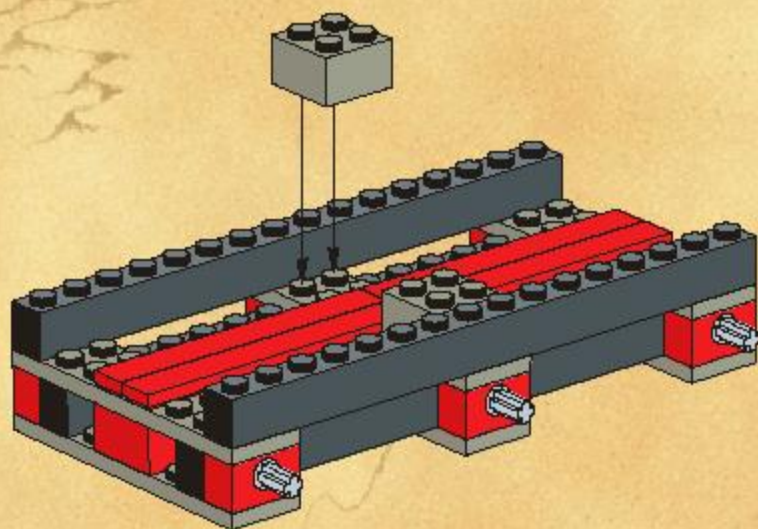

8

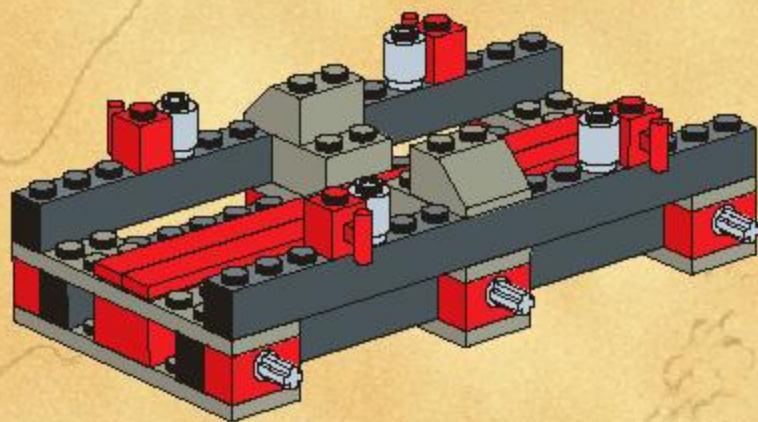

I

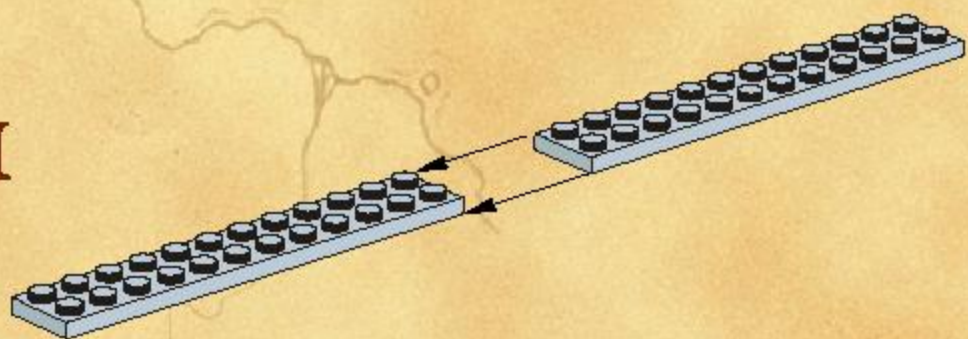

2

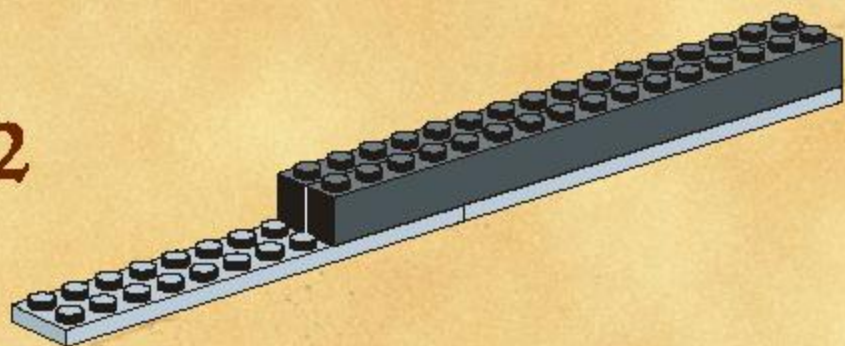

3

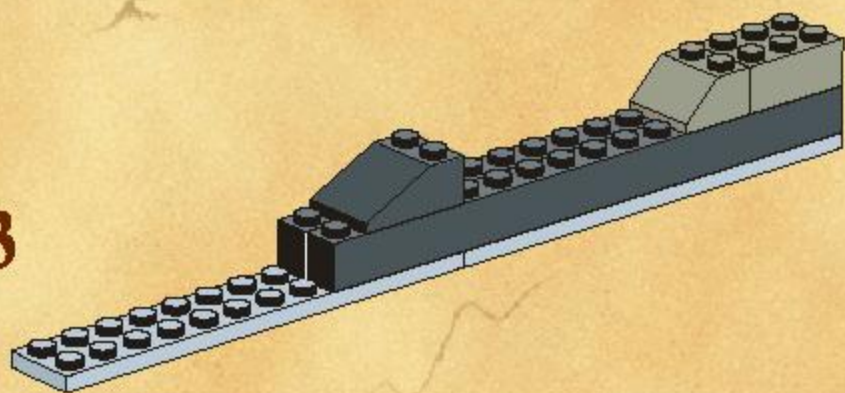

4

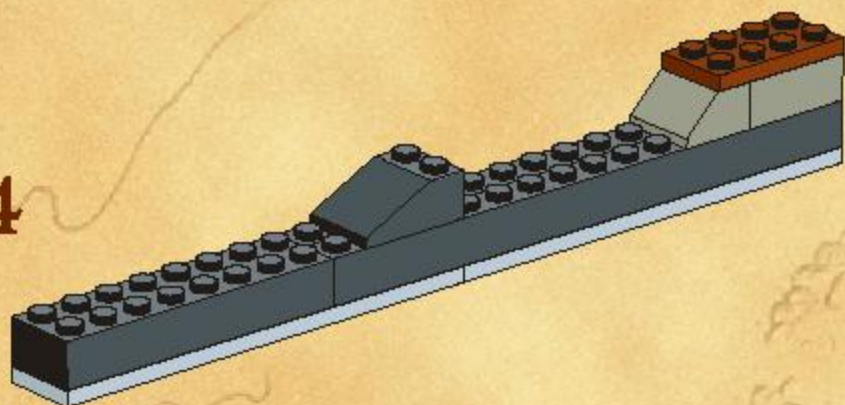

5

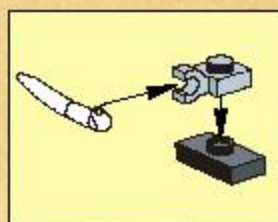
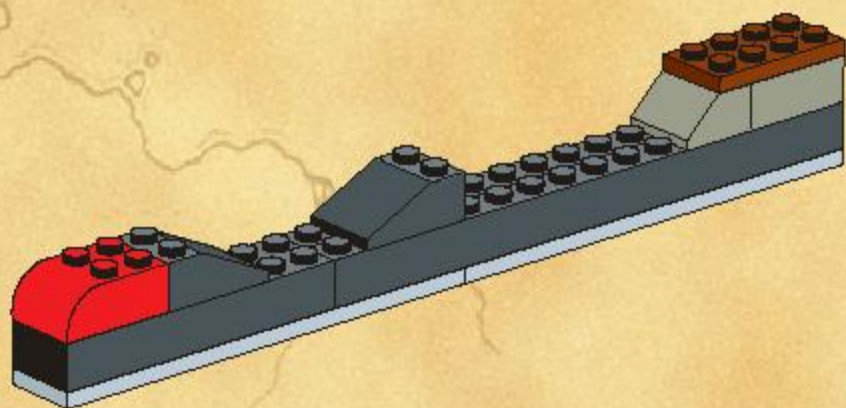

6

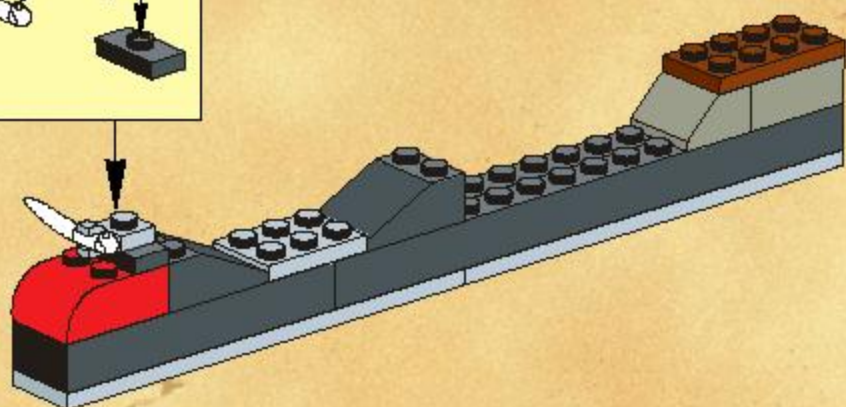

9

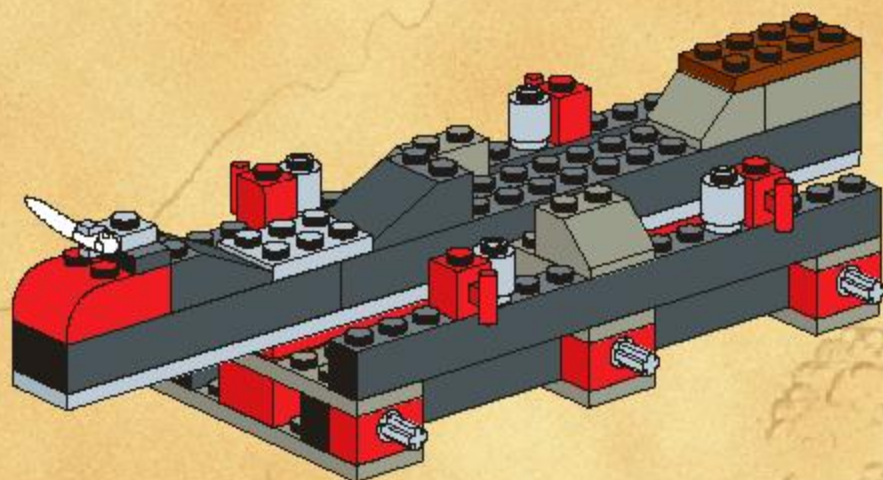

10

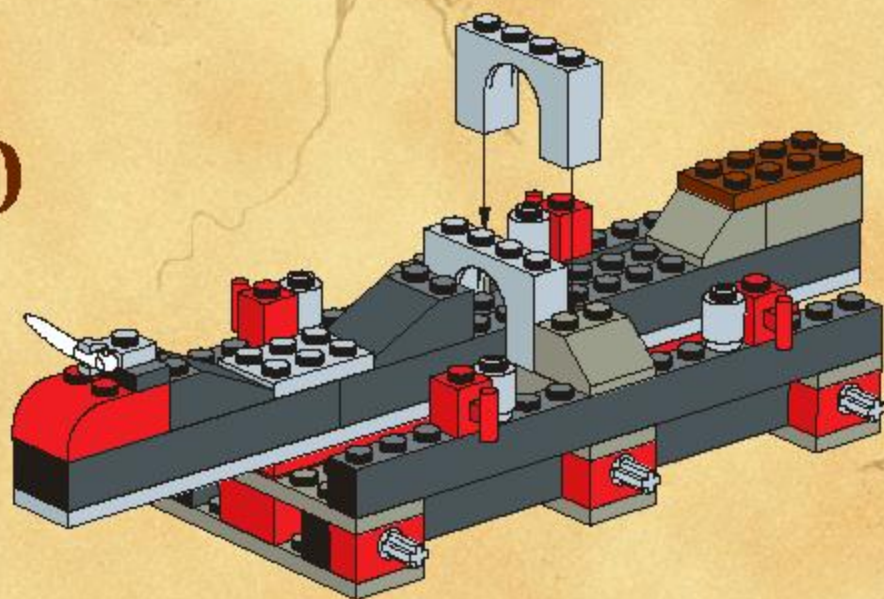

11

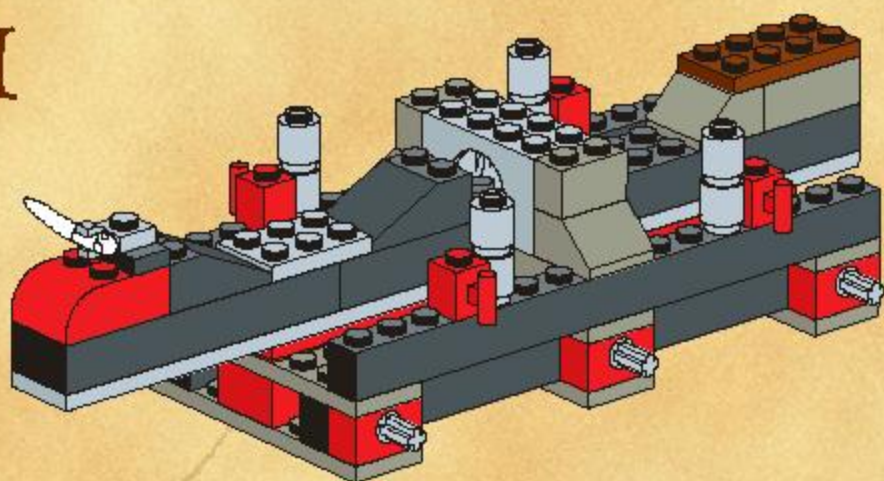

I2

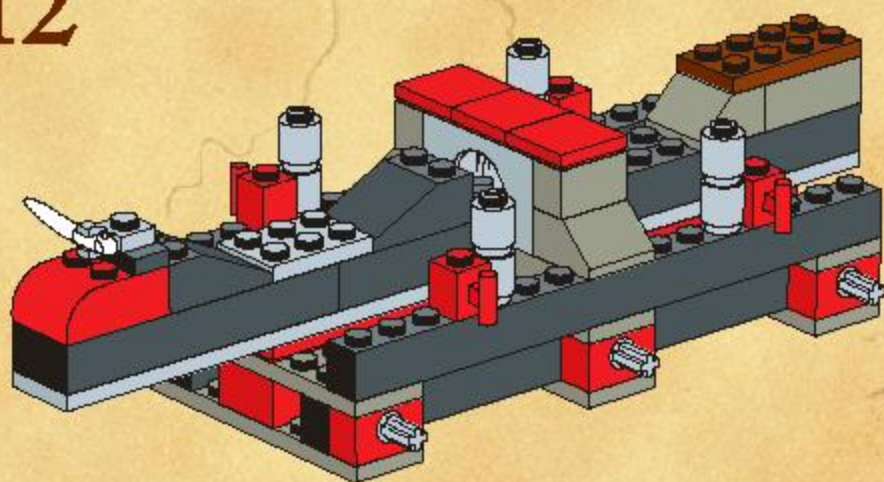

I3

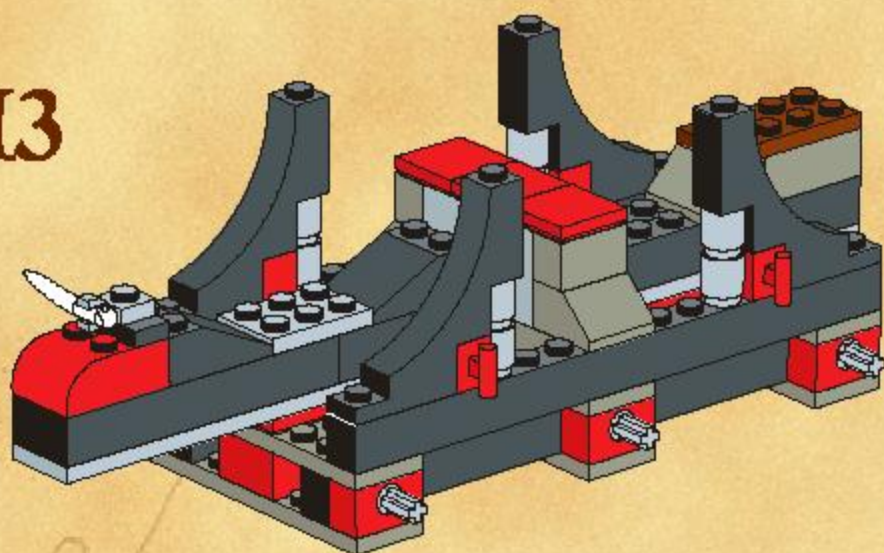

14

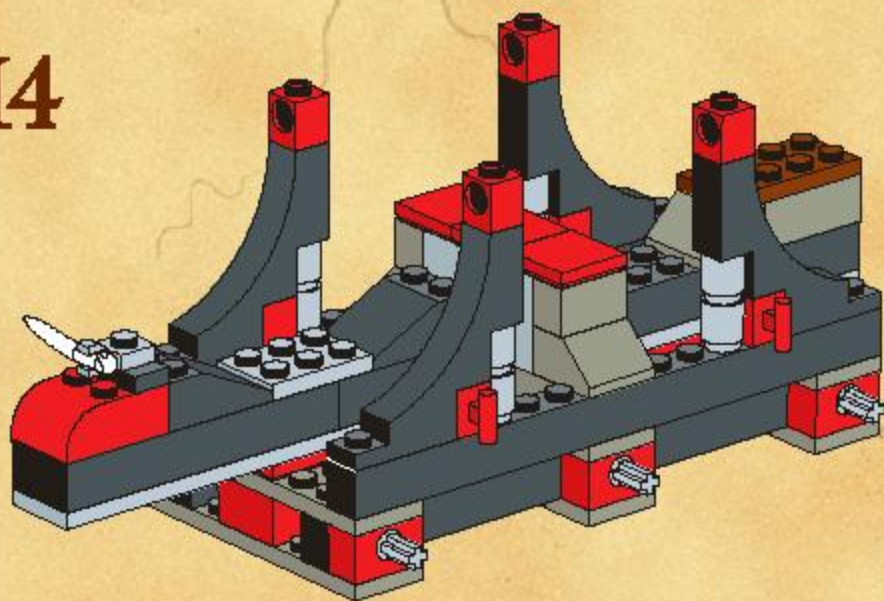

15

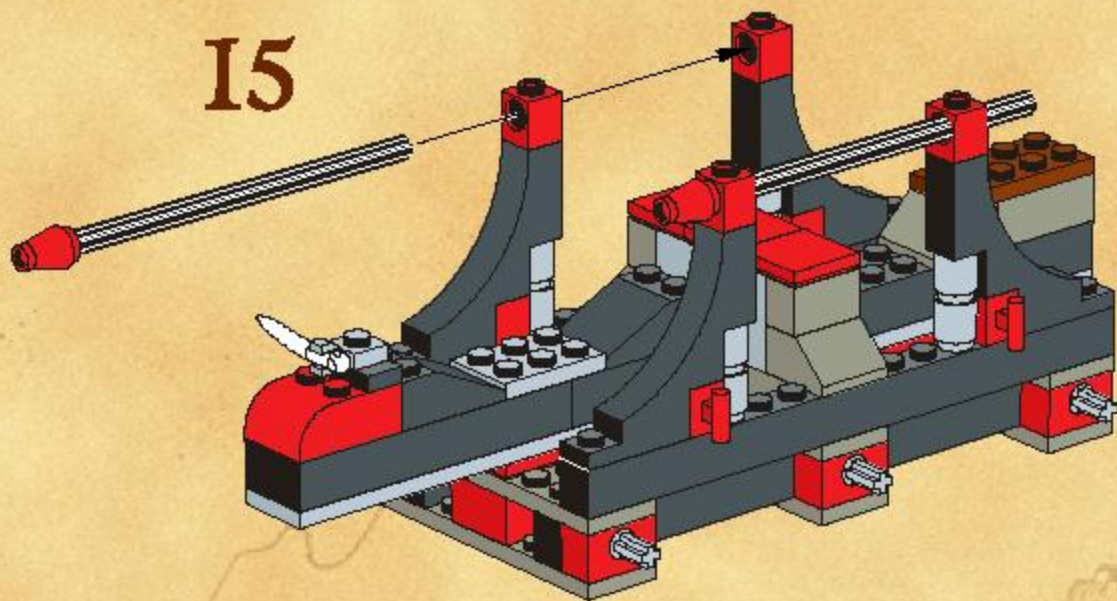

I6

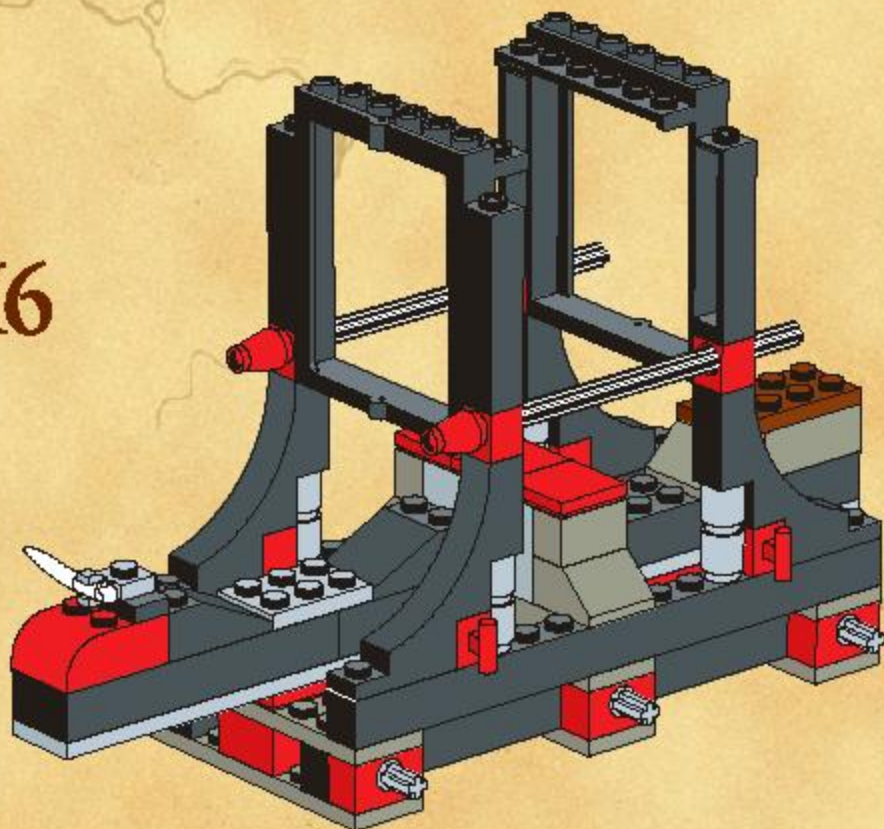

I7

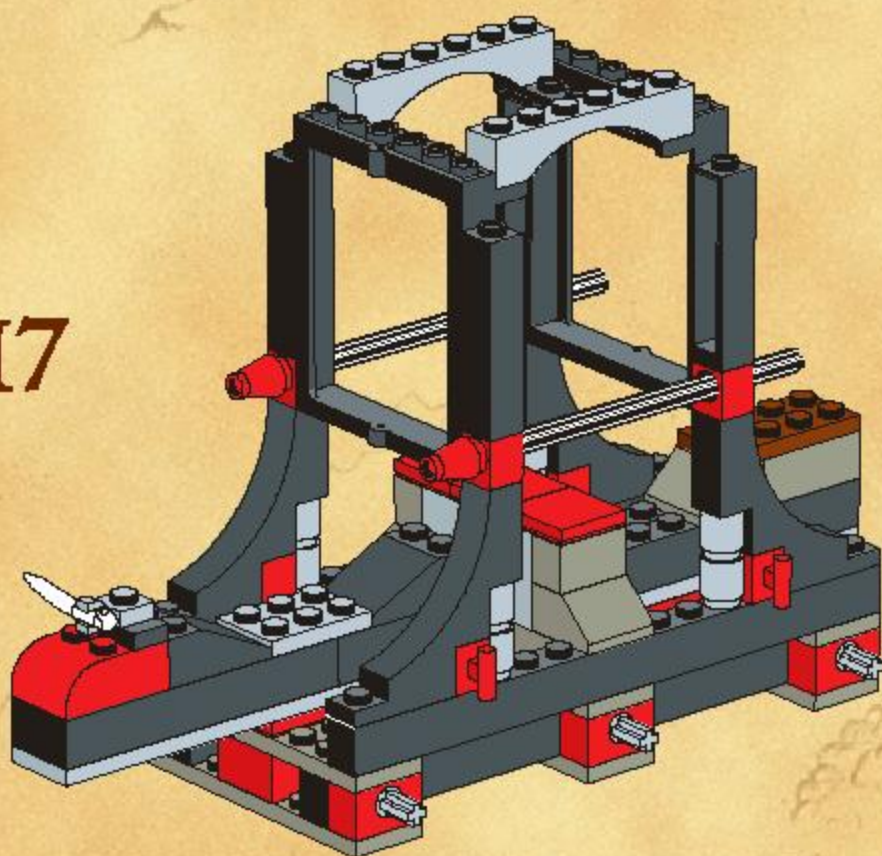

I8

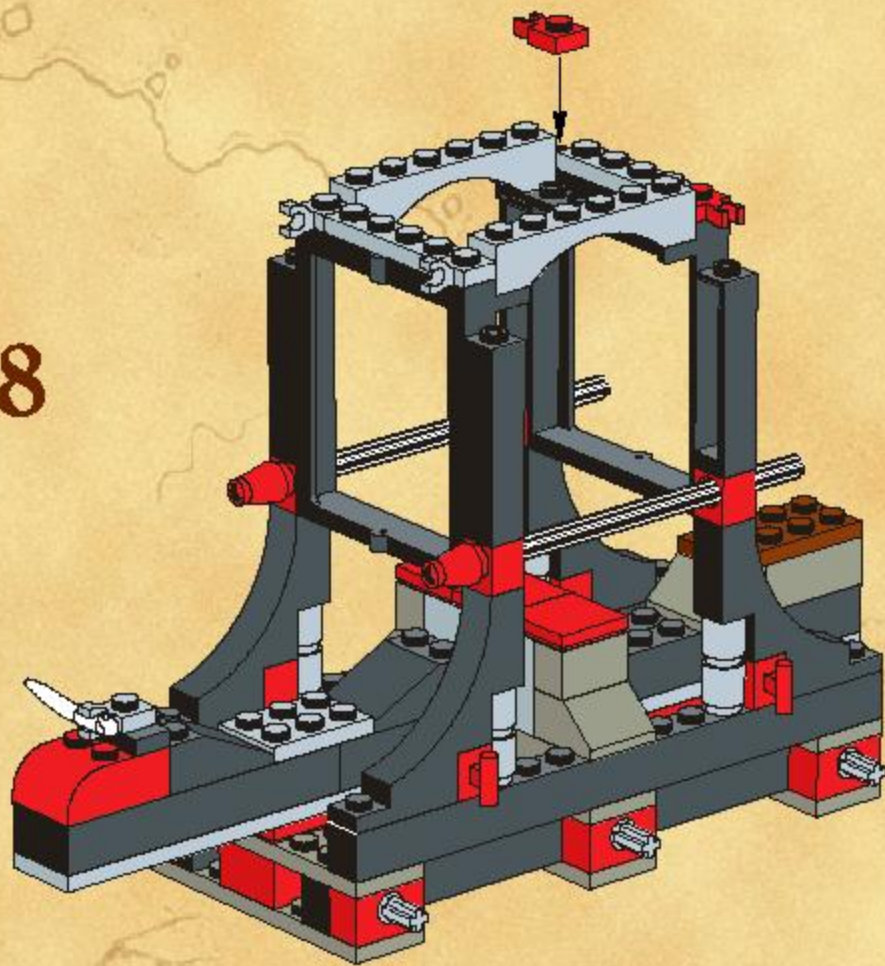

I9

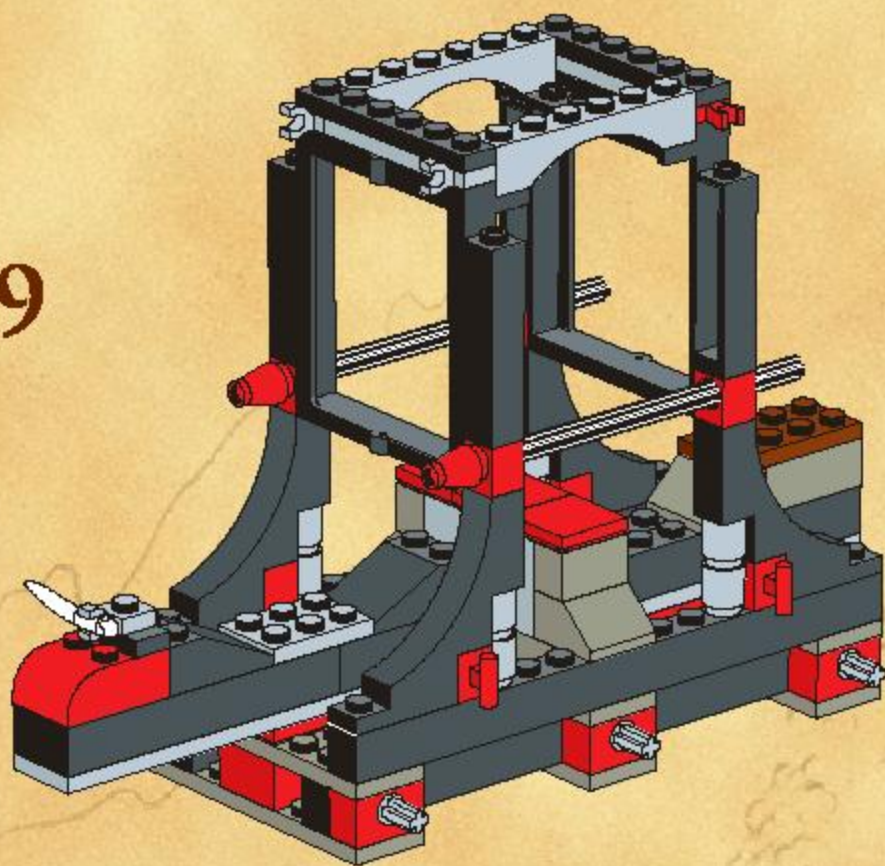

20

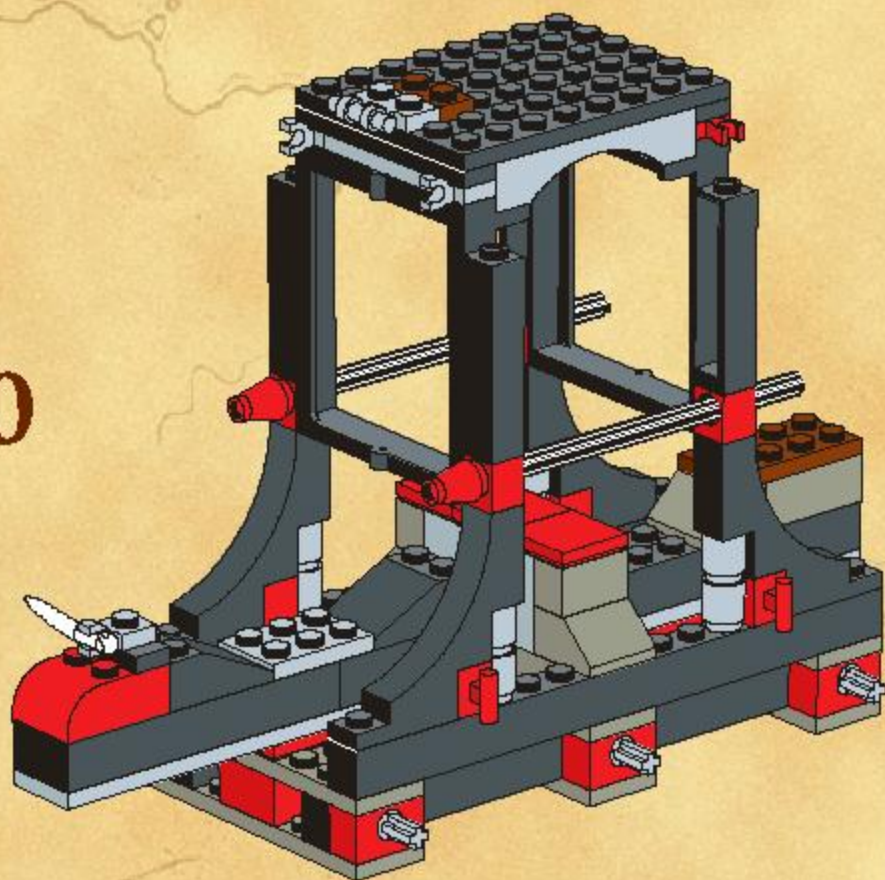

21

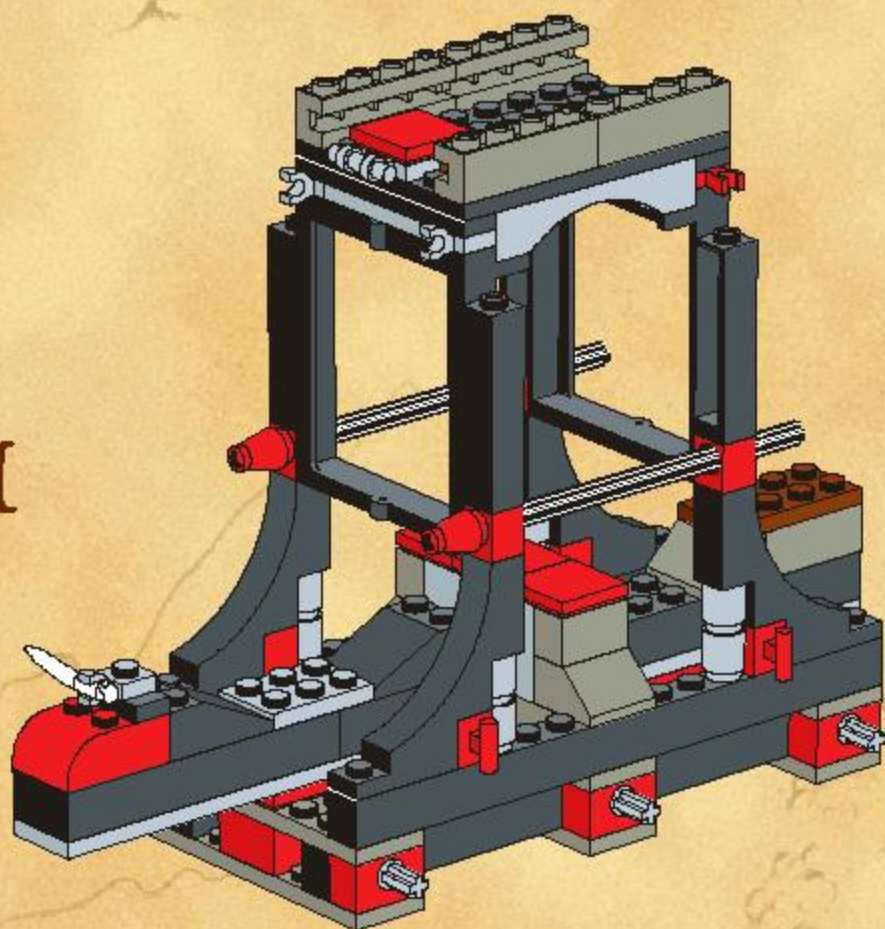

I

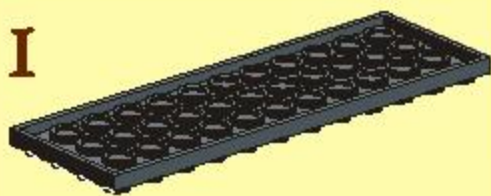

2

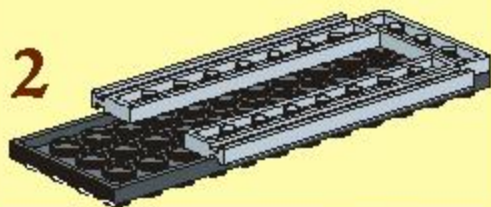

22

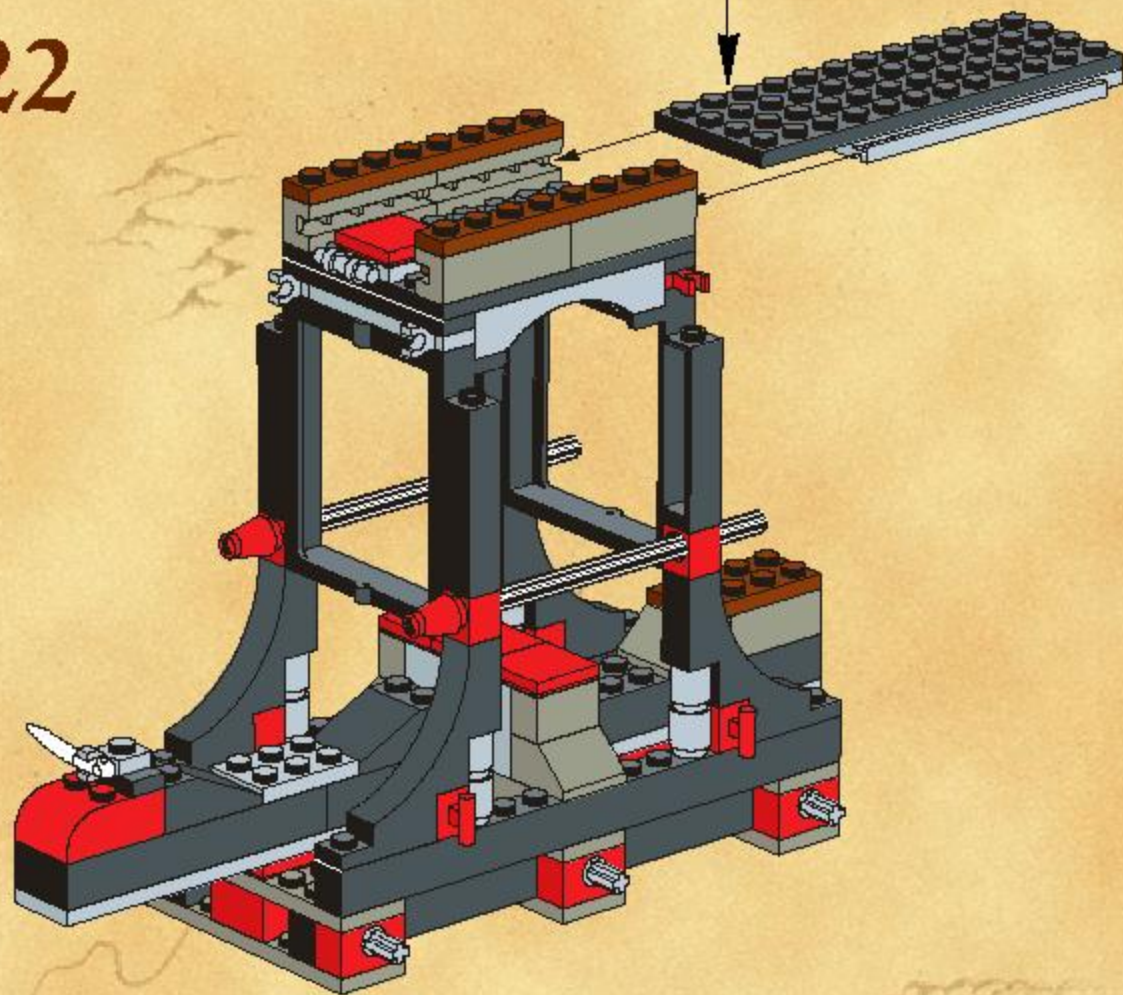

23

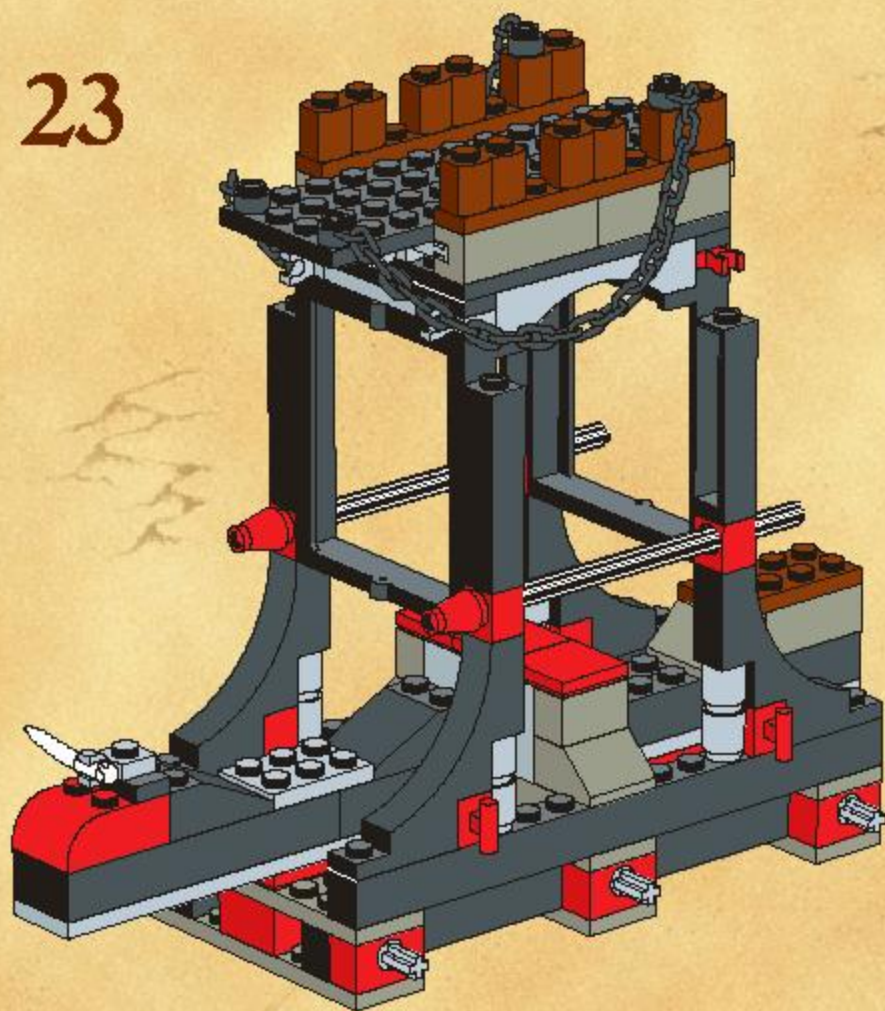

24

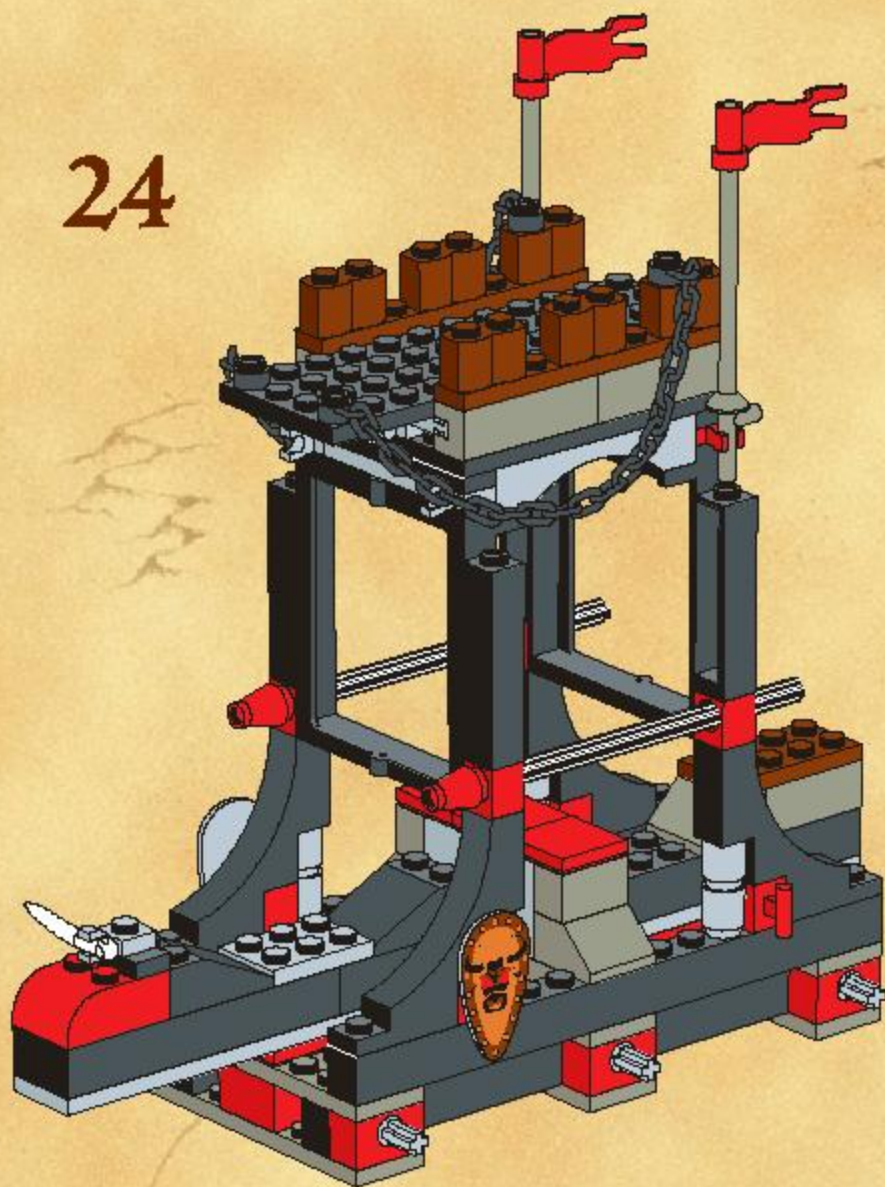

25

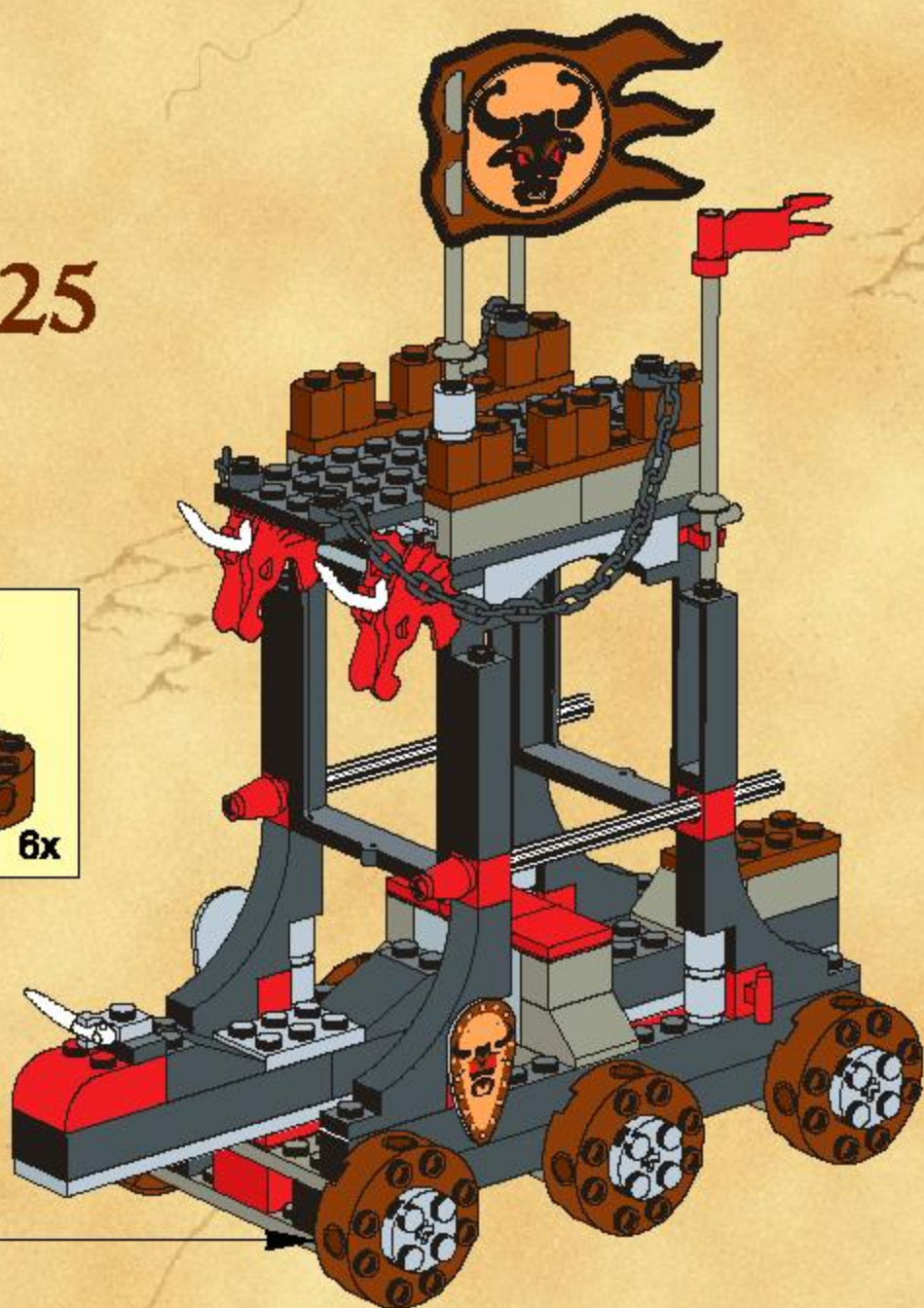
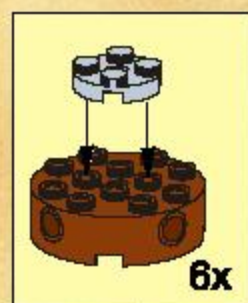

1

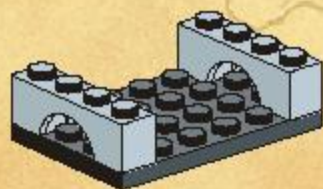

2



3

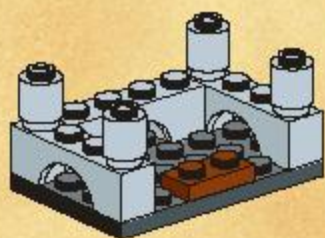

4



5

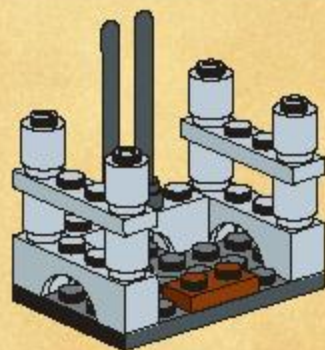

6

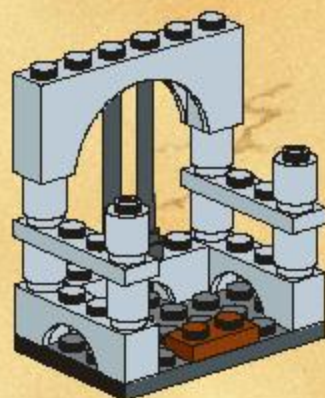

7

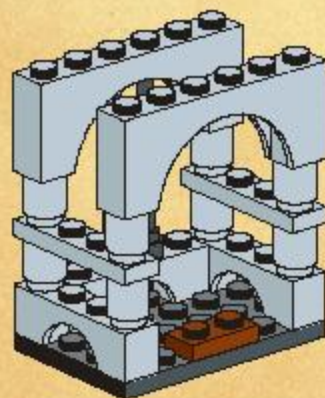

8



26

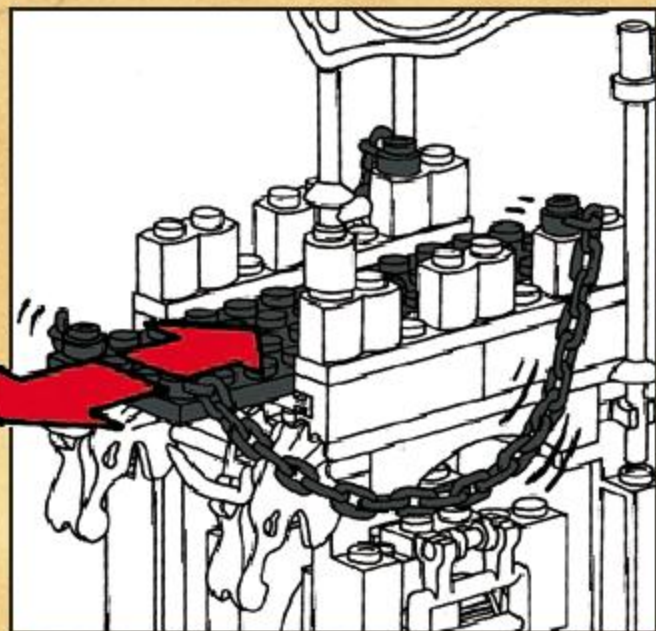
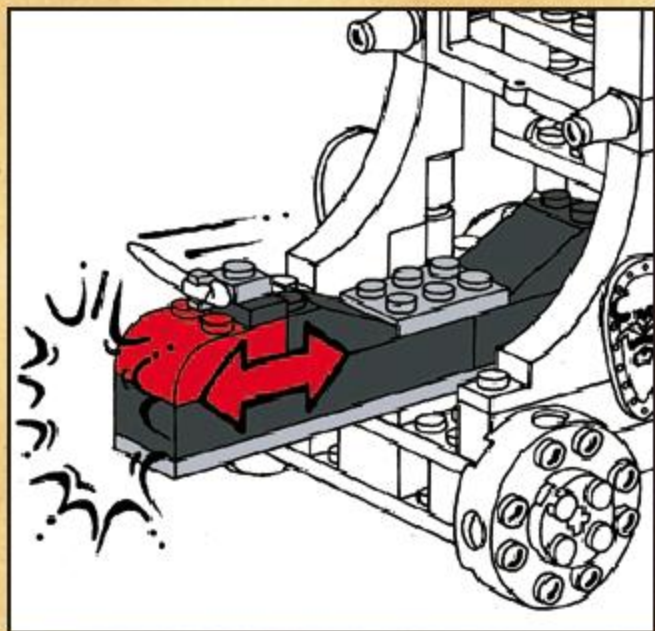
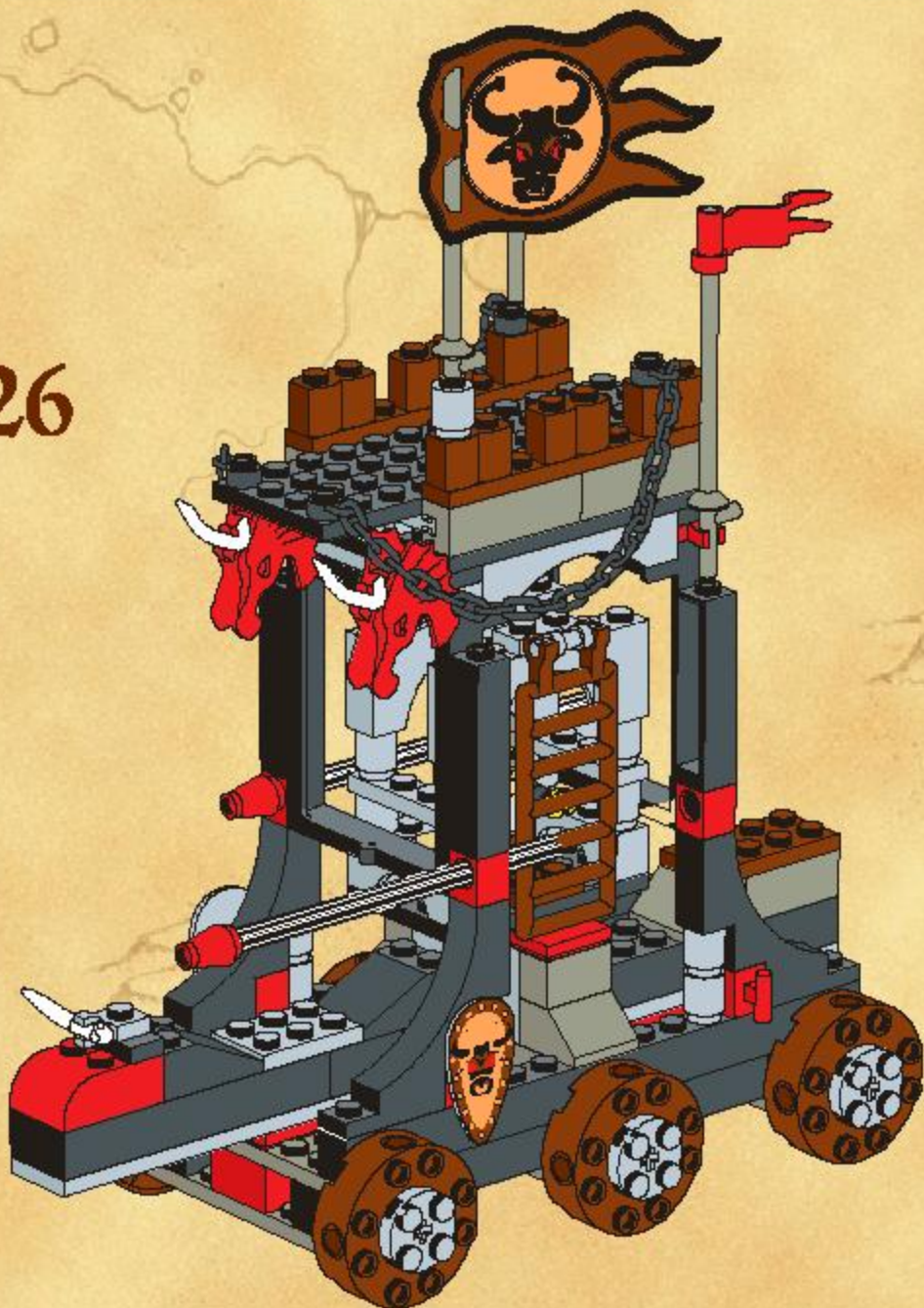



I



2

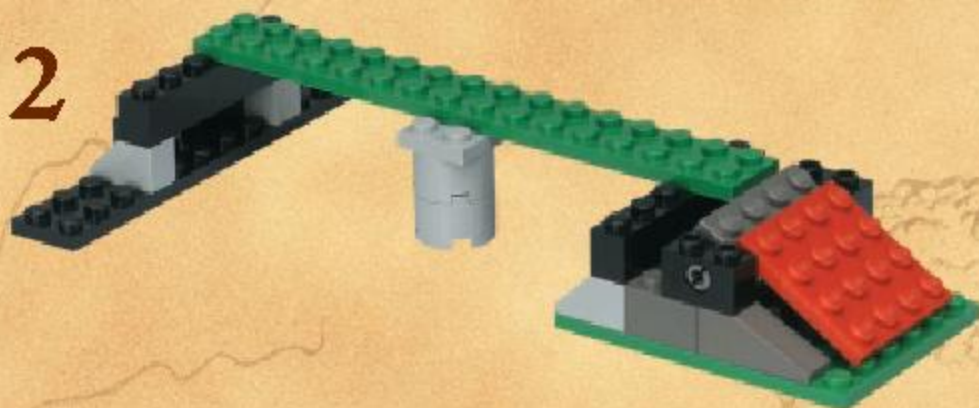

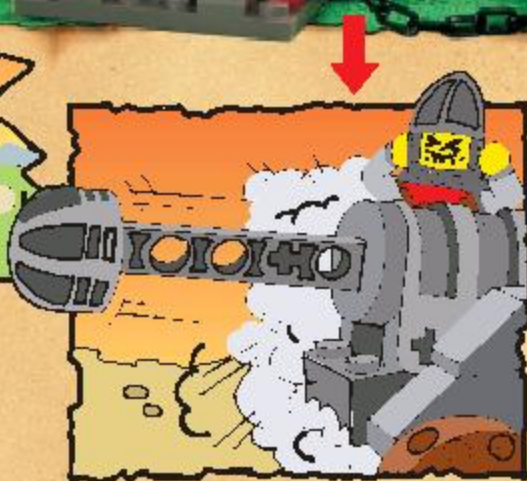

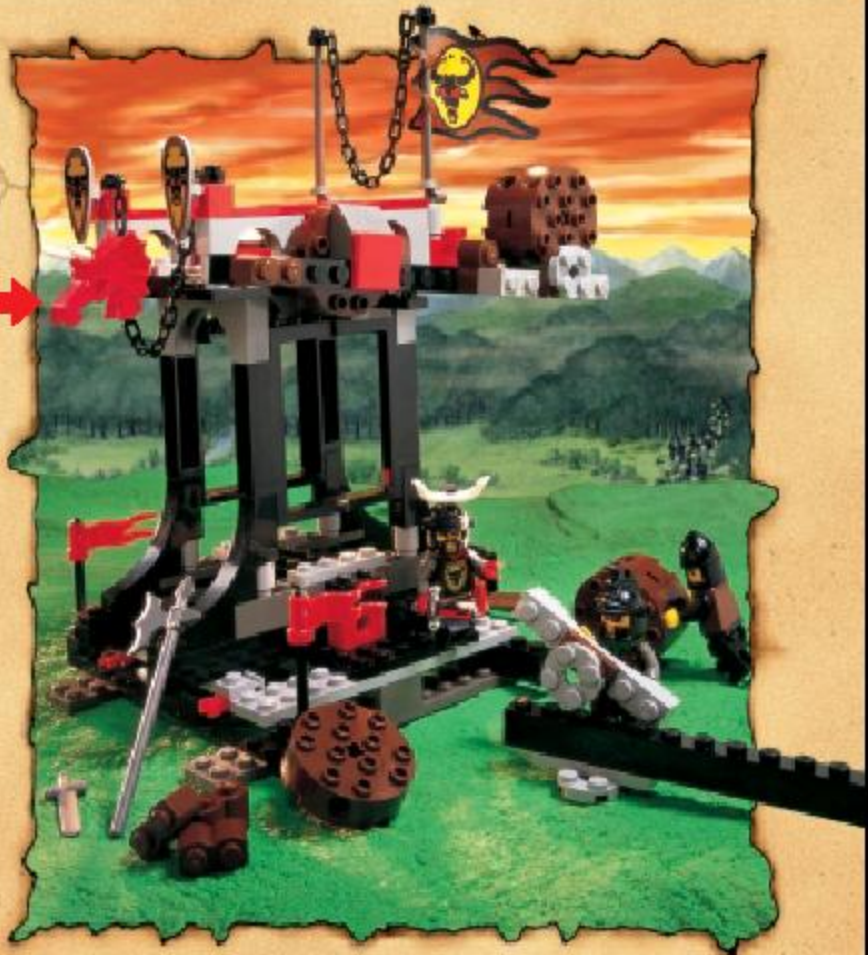

1



2



3

